

Goodrive20/Goodrive310 Series

General Purpose Vector Control Drive

Your Trusted Industry Automation Solution Provider

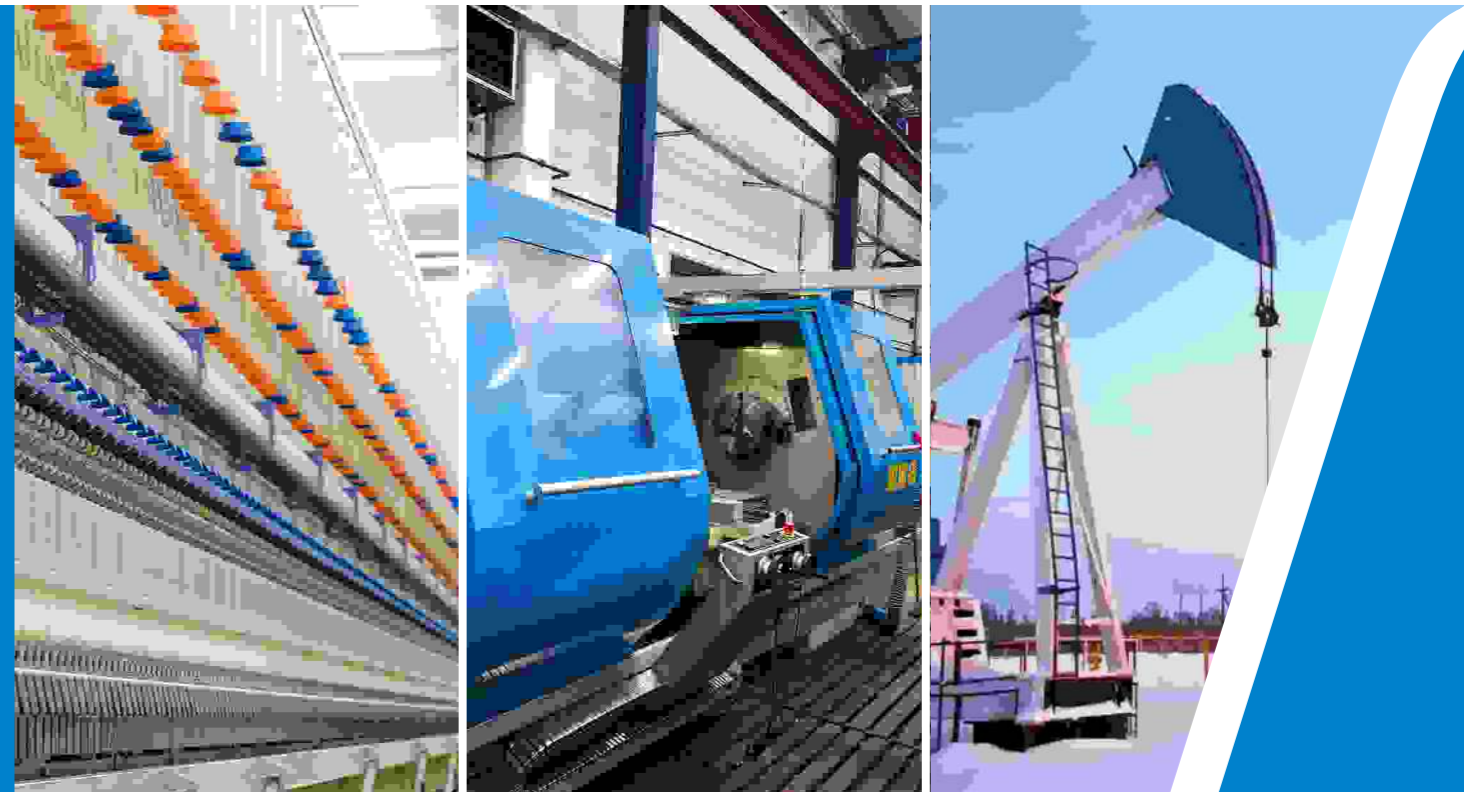

Service line:86-755-23535967 E-mail:overseas@invt.com.cn Website:www.invt.com

SHENZHEN INVT ELECTRIC CO., LTD.

INVT Guangming Technology Building, Songbai Road, Matian, Guangming District, Shenzhen, China

- | | | | | |
|-------------------------------|--|---------------------------------------|----------------------------|-----------------------------------|
| Industrial Automation: | • Variable-Frequency Drive | • Servo & Motion Control | • Motor & Electric Spindle | • PLC |
| | • HMI | • Intelligent Elevator Control System | • Traction Drive | |
| Electric Power: | • SVG | • Solar Pump Controller | • UPS | • Online Energy Management System |
| | • New Energy Vehicle Electric Control System | | | |

INVT Copyright.
Information may be subject to change without notice during product improving.

66003-00110 Y9/1-07(V1.0)



Low Voltage Drive Family.....02
 Product Introduction.....02
 Product Advantage.....02

Goodrive20 Series Mini Vector Control VFD..... 03
 Product Advantage03
 Product Features04
 Applications07
 Technical Specifications08
 Standard Wiring.....09
 Type Selection.....09
 Optional Parts.....10

Goodrive310 Series General Purpose Vector Control VFD.....11
 Product Advantage.....11
 Combined Drive12
 Multi-function with simple operation15
 Reliable quality assurance.....18
 3 International Communication Protocols.....20
 Applications.....21
 Technical Specifications.....22
 Power Ratings.....23
 Dimensions.....24
 Optional Parts27

Sales Network30

Low Voltage Drive Family



Product Advantage

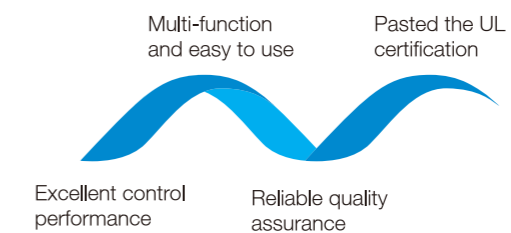



Goodrive20 Series Mini Vector Control VFD

Goodrive20 series mini type general vector VFD, positioned as using the high performance mini product of small power market; product using the leading international vector control algorithm, with excellent product features, compatible with wall and rail installation, and the product volume is smaller. Product widely used in Textile machinery, Food machinery, Plastic machinery, Printing and packaging, Environmental protection equipment, Ceramic equipment, Woodworking equipment, Conveying equipment and so on industries.

Product Advantage

- Mini structure
- Easy maintenance
- Various installation ways
- Excellent performance
- Multi-function and easy to use



Product Features

New Structure Design

- Mini design, smaller installation space
- Compatible with rail and wall installation, flexible installation manner



Rail mounting

Wall mounting

- Available multi-VFD in parallel installation, more effective space-saving



In parallel installation, need to remove the membranes on the top of the VFDs

Easy Maintenance

- External keypad
The standard keypad is membrane keypad. Support external LED keypad. The LED keypad support parameter copy.



- Plug cooling fan, easy maintenance



Reliable QA

- The product design strictly follows IEC international standards and passed CE and UL certification



- Advanced thermal technology makes exact thermal design

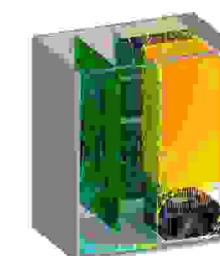

Excellent Performance

- Excellent vector control performance

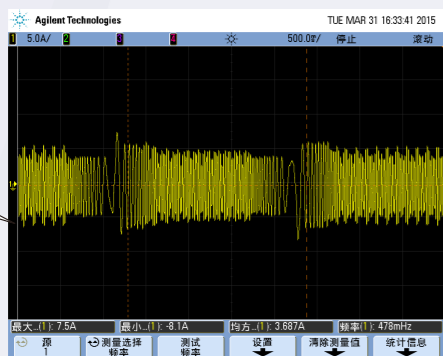

Current waveforms in vector control mode with 50Hz and full load

- Excellent motor drive performance

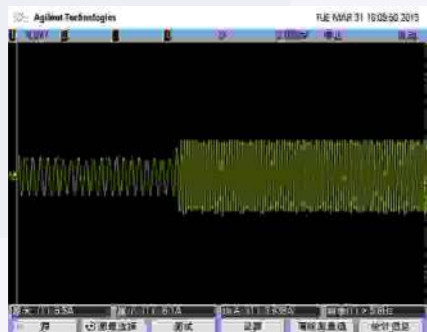

Current waveforms when sudden loading in V/F control mode with 2Hz and full load

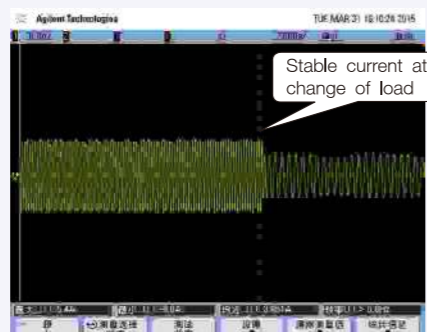

Current waveforms when sudden unloading in V/F control mode with 2Hz and full load



Current waveforms when sudden loading in vector control mode with 0.5Hz and full load

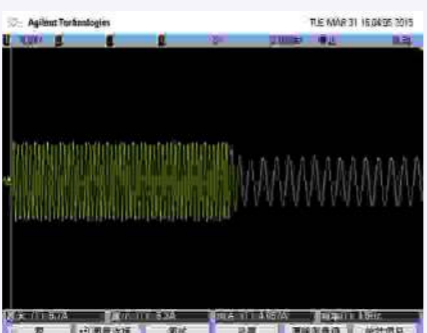

Current waveforms when sudden unloading in vector control mode with 0.5Hz and full load

- Excellent high frequency running performance

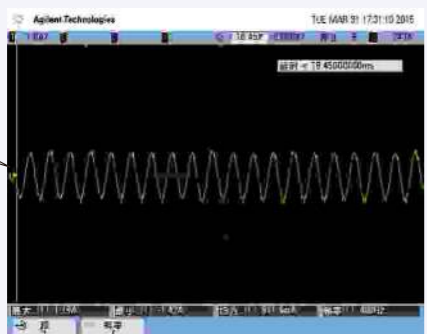

Current waveforms when stably running in vector control mode with 400Hz

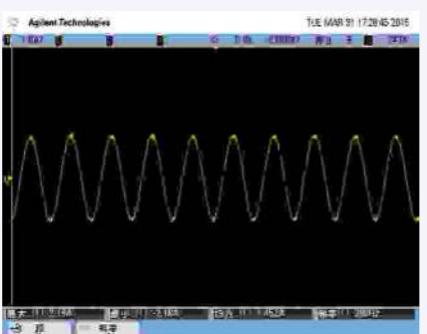

Current waveforms when stably running in vector control mode with 200Hz

Multi-Function and Easy to Use

Name	Function	Illustration
RS485 communication	Connect with upper computer, read and modify parameters of the VFD, control running states of the VFD	Standard built-in RS485 communication interface
PID	Carry out PID operation on feedback signals, control output frequency of the VFD and improve target accuracy and stability; apply to pressure, flux and temperature process control	Support PID output polarity switching
Motor autotuning	Carry out rotation or static auto-tuning, improve control accuracy and response speed	Include rotation auto-tuning and static auto-tuning
Simple PLC	Can change the running frequency and direction automatically according to the running time set by simple PLC to meet process requirements	Support multiple running modes
Multi-step speed control	Can meet the requirements of speed control in different periods of time via multi-step speed control	Max. available 16-step speed control
Multiple V/F curve settings	Meet the requirements of fans and water pumps in energy-saving operation and various variable frequency power supplies, adapt to different load applications	Linear, multi-dot, multi-powerandV/Fseparationsettings, realize flexible setting of V/F curves
Virtual terminals	Can take external signals as local virtual I/O to save hardware configuration	Enable the corresponding virtual terminal functions in communication mode
Delay switching on and off	Provide more programming and control modes	Max. switching on-off delay is 50s
Continuous running in instantaneous power off	Specially apply to the situations with high requirement of continuous operation, ensure the device does not stop in instantaneous power off	At transient voltage drop, the VFD can keep running by feedback energy without stop in valid time
Various protection functions	Provide overall fault protection functions	Protection functions such as overcurrent, overvoltage, undervoltage, overheating, overload, can save fault information
Optional braking modes	Provide multiple braking modes, satisfy accurate and quick stop under different loads	DC braking, Flux braking, Dynamic braking
Battery capacity display	Can display the accumulative power consumption on the VFD in no need of watt-hour meter	Can check power consumption of the VFD

Applications

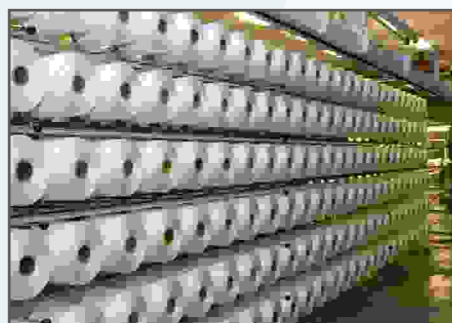

Textile machinery

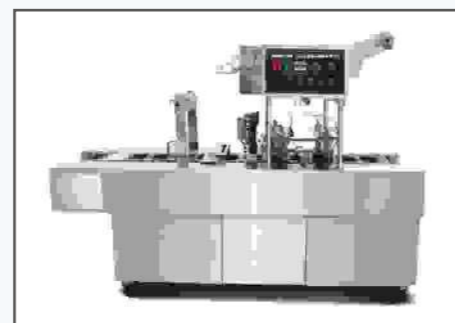

Food machinery

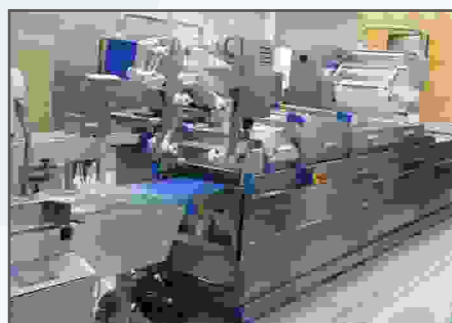

Plastic machinery

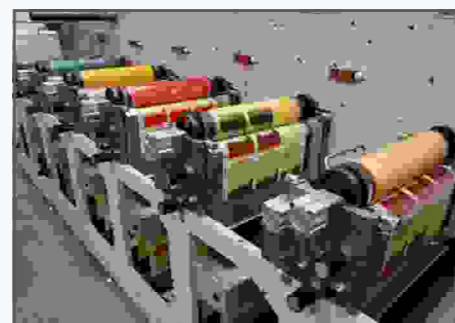

Printing and packaging



Environmental protection equipment



Ceramic equipment



Woodworking equipment

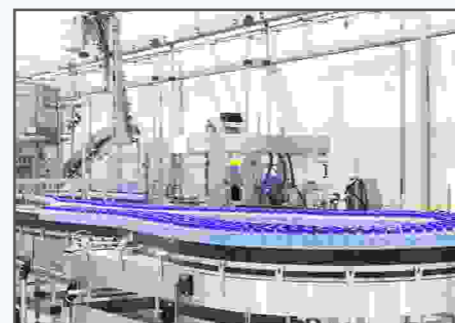

Conveying equipment

Technical Specifications

	Function	Specification
Power input	Input voltage (V)	1PH 220V (-15%)~240V 3PH 380V (-15%)~480V
	Input current (A)	Refer to the rated value
	Input frequency (Hz)	50Hz or 60Hz, allowed range: 47~63Hz
Power output	Output motor capacity (kW)	Refer to the rated value
	Output current (A)	Refer to the rated value
	Output voltage (V)	0-Input voltage, error<5%
Technical control feature	Control mode	SVPWM, SVC
	Adjustable-speed ratio	1:100
	Speed control accuracy	±0.2% (SVC)
	Speed fluctuation	± 0.3% (SVC)
	Torque response	≤20ms (SVC)
	Torque control accuracy	10%
	Starting torque	0.5Hz/150% (SVC)
Running control feature	Overload capability	150% of rated current: 1 minute 180% of rated current: 10 seconds 200% of rated current: 1 second
	Frequency setting method	Digital setting, analog setting, pulse frequency setting, multi-step speed running setting, simple PLC setting, PID setting, MODBUS communication setting
	Auto-adjustment of the voltage	Keep a stable voltage automatically when the grid voltage transients
Peripheral interface	Fault protection	Provide comprehensive fault protection functions: overcurrent, overvoltage, undervoltage, overheating, phase loss and overload, etc.
	Analog input	1 (AI2) 0~10V/0~20mA and 1 (AI3) -10~10V
	Analog output	2 (AO1, AO2) 0~10V/0~20mA
	Digital input	4 common inputs, the Max. frequency: 1kHz; 1 high speed input, the Max. frequency: 50kHz
	Digital output	1 Y terminal output
Others	Relay output	2 programmable relay outputs RO1A NO, RO1B NC, RO1C common terminal RO2A NO, RO2B NC, RO2C common terminal Contactor capacity: 3A/AC250V
	Mountable method	Wall and rail mountable
	Braking unit	Embedded
	EMI filter	Optional filter: meet the degree requirement of IEC61800-3 C2, IEC61800-3 C3
	Temperature of the running environment	-10~50°C, If above 40°C, derate 1% for every additional 1°C.
	Altitude	<1000m If the sea level is above 1000m, please derate 1% for every additional 100m.
	Protective degree	IP20
	Safety	Meet the requirement of CE&UL
Cooling	Air-cooling	

Standard Wiring

Wiring Diagram of Control Circuit

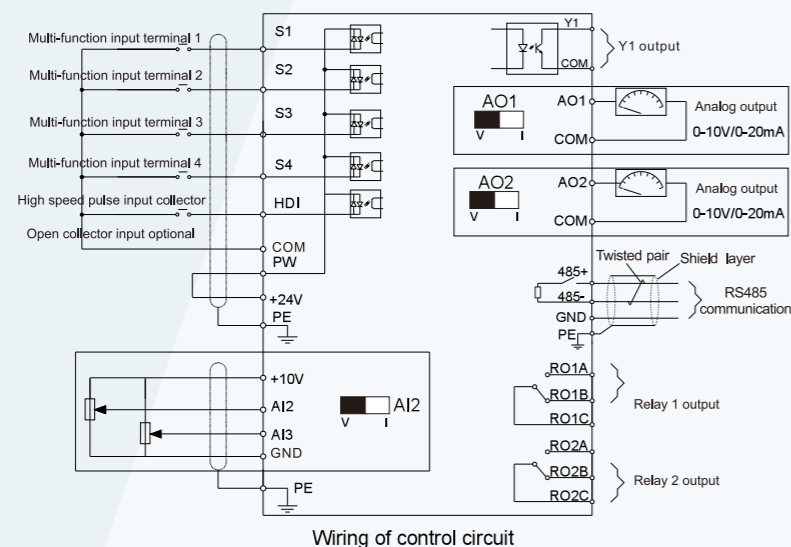

Type Selection

Type Designation Key

GD20-1R5G-4-UL

① ② ③ ④

Key	No.	Detailed description	Detailed content
Abbreviation	①	Product abbreviation	GD20 is short for Goodrive20
Rated power	②	Power range+load type	1R5-1.5kW G: constant torque load
Voltage degree	③	Voltage degree	S2: AC 1PH 200V~240V Rated voltage: 220V 4: AC 3PH 380V~480V Rated voltage: 460V
Certification	④	Certification standards	CE(Default) : Meet CE certification requirements UL: Meet UL certification requirements

Power Ratings and Dimensions

Model	Rated output power (kW)	Rated output horsepower(HP)	Rated input current (A)	Rated output current (A)	Gross weight (kg)	Dimension (mm) W*H*D
GD20-0R4G-S2-UL	0.4	0.5	6.5	2.5	1.4kg	80*160*123.5
GD20-0R7G-S2-UL	0.75	1	9.3	4.2		
GD20-1R5G-S2-UL	1.5	2	15.7	7.5	1.7kg	80*185*140.5
GD20-2R2G-S2-UL	2.2	3	24	10		
GD20-0R4G-2-UL	0.4	0.5	3.7	2.5		
GD20-0R7G-2-UL	0.75	1	5.0	4.2	1.3kg	80*185*140.5
GD20-0R7G-4-UL	0.75	1	3.4	2.5		
GD20-1R5G-4-UL	1.5	2	5.0	4.2		
GD20-2R2G-4-UL	2.2	3	5.8	5.5		

Optional Parts

External LED Keypad

Including the external keypads with and without the function of parameter copying. The external keypad without the function of parameter copying apply to common applications and commissioning situations; the external keypad with the function of parameter copying apply to the situations when multiple VFDs are in commissioning at the same time and need parameter copying.



Reactor

Input reactor: Improve the power factor of the input side of the VFD and control the higher harmonic current.
Output reactor: Prolong the effective transmitting distance of the VFD and control the sudden high voltage when switching on/off the IGBT of the VFD.



Filter

Input filter: Control the electromagnetic interference generated from the VFD, please install close to the input terminal side of the VFD.
Output filter: Control the interference from the output side of the VFD, please install close to the output terminals of the VFD.

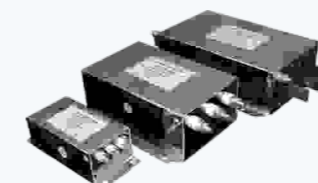

Braking Resistor

Shorten the Decelerate time.
Only braking resistors are needed for Goodrive20 VFDs.

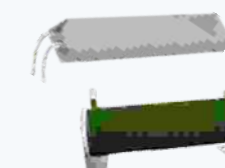

Dam-board of Heat Releasing Holes at the Side

Apply to severe environment and improve protective effect.
Derate 10% of the machine.



Keypad Bracket

Use it to install the keypad on the front of cabinet



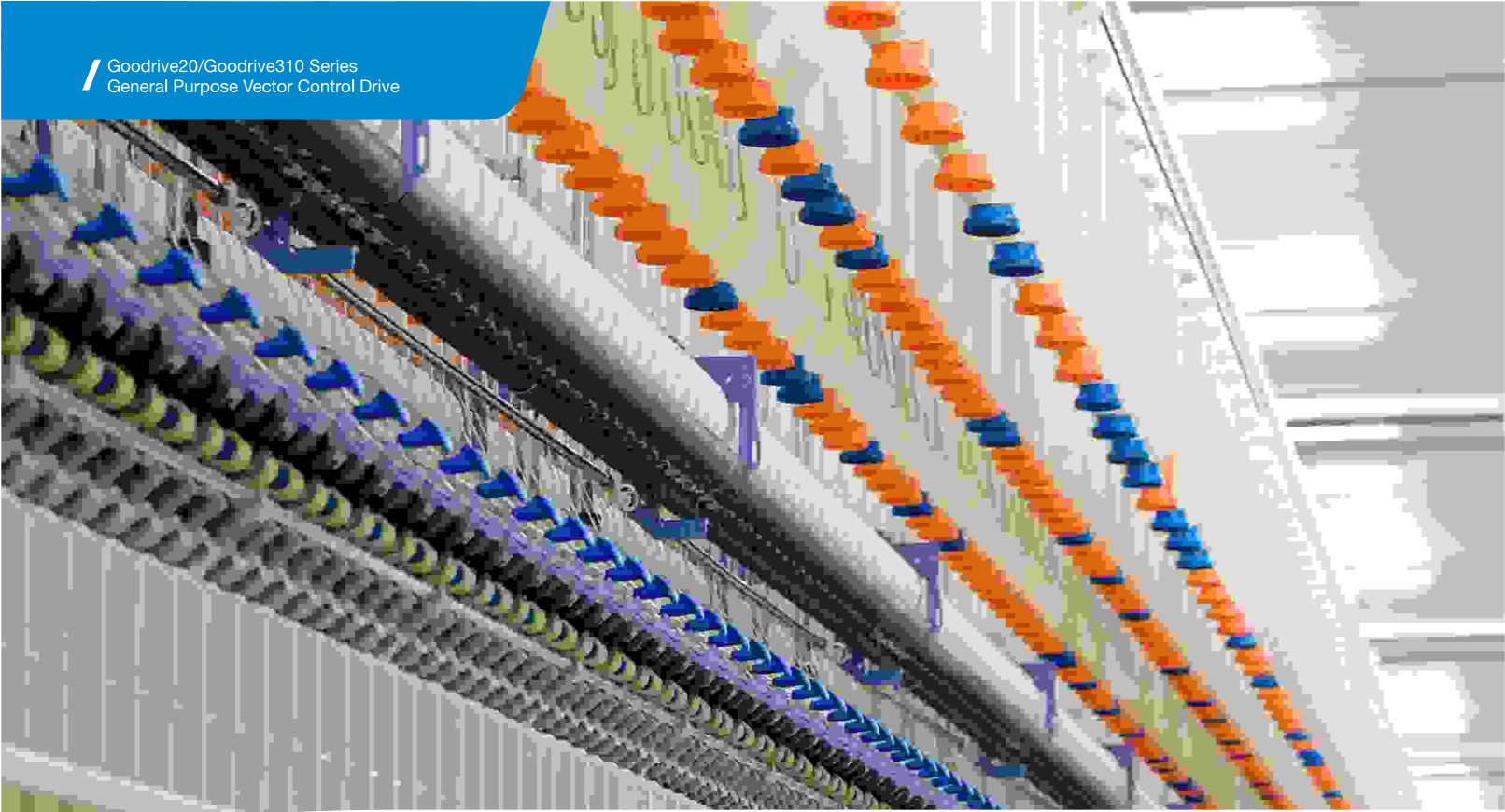

Combined Drive

Compatible with Multiple Motors

Vector drive for asynchronous AC induction motors and permanent magnet synchronous motors. Reduce the inventory effectively without considering the motor compatibility.



Remarks:
1. The traditional permanent magnet synchronous motor includes SPM and IPM.
2. The variable frequency motor includes high speed spindle.

More Accurate Motor Autotuning

Correct rotating and static motor autotuning. Convenient debugging, easy operation.

Rotating Autotuning

Need to separate motor from the load, Applied to the situation with high control accuracy

Static Autotuning

No need to separate motor from the load, Applied when rotating autotuning is not available

Goodrive310 Series General Purpose Vector Control VFD

Goodrive310 series VFDs are high performance open loop vector VFDs for controlling asynchronous AC induction motors and permanent magnet synchronous motors. Applying the most advanced sensorless vector control technology which keeps pace with the leading international technology and DSP control system, the product enhances its reliability to meet the requirement of environment adaptability, customized and industrialized design with more optimized functions, more flexible application and more stable performance.

Product Advantage

- Combined Drive
- Multi-function with simple operation
- Reliable quality certificated by TÜV SÜD
- 3 International Communication Protocols



Optimized SVPWM Control

The current, torque and rotating speed waveforms when sudden loading or unloading in asynchronous motor SVPWM control mode with 2Hz running frequency and full load.

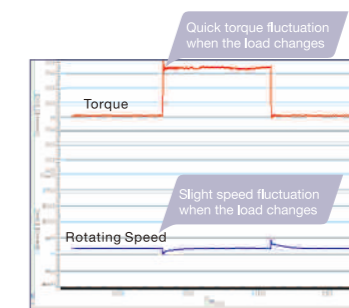
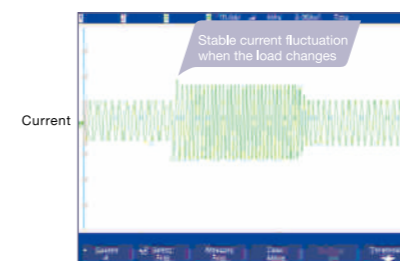

Advanced Open Loop Vector Control

Asynchronous Motor

Starting Torque	Dynamic Response	Speed Ratio	Steady Speed Accuracy
0.25Hz/150% of rated torque	<20ms	1 200	±0.2%

The current, torque and rotating speed waveforms when sudden loading or unloading in asynchronous motor open loop vector control mode with 0.25Hz running frequency and full load.

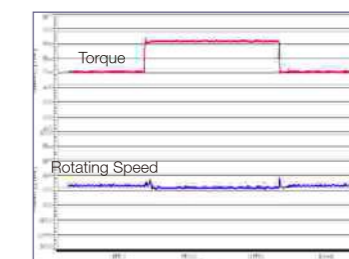
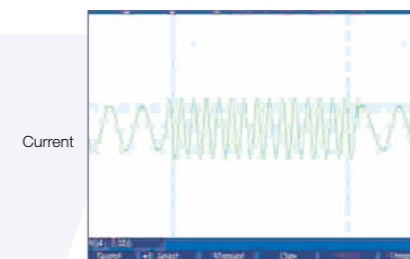

Synchronous Motor

Starting Torque

2.5Hz/150% of rated torque

Dynamic Response

<40ms

Speed Ratio

1: 20

The current, torque and rotating speed waveforms when sudden loading or unloading in synchronous motor open loop vector control mode with 3Hz running frequency and full load.

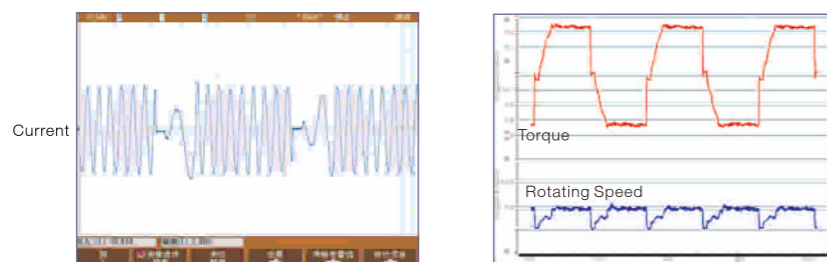

Torque Control Mode(open loop)

The current, torque and rotating speed waveforms when sudden loading or unloading in asynchronous motor torque control mode with full load.

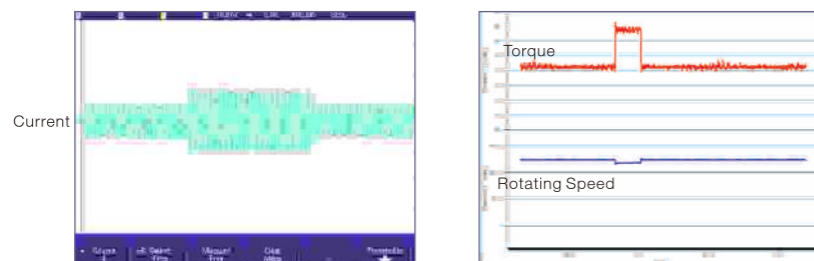

The FWD/REV current, torque and rotating speed waveforms in synchronous motor torque control mode with 100Hz running frequency and full load.

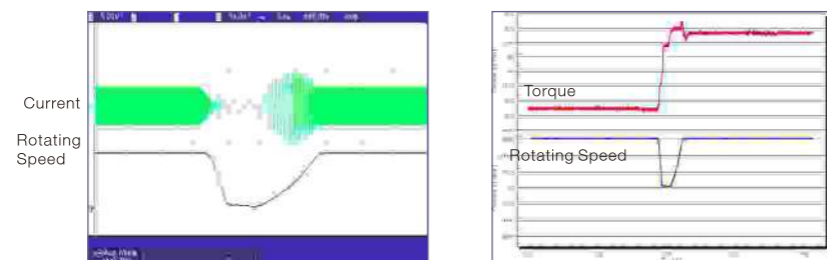

More Smoother and More Quietter Running by Applying Advanced 3-phase Modulation

Excellent Performance on Specific Motors such as High Speed Spindle, Direct-control Motor

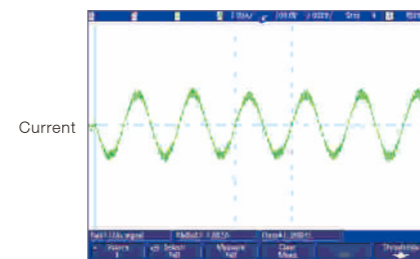
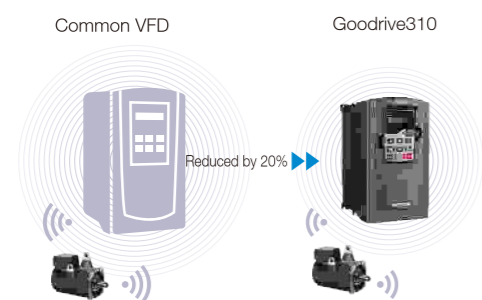

The current waveforms in synchronous motor open loop vector control mode with 300Hz running frequency and full load.

Multiple Braking Modes and Instant Stopping

Dynamic Braking

Configure braking units and resistors
Available on the situation of big inertia load and frequent braking
Big braking torque and quick braking

DC Braking

No need to configure braking units and resistors
Available on the situation when start the running motor after braking and the situation when keep the moment output after braking to zero speed
Not available on the situation of big inertia load or instant stopping braking in high speed running

Flux Braking

No need to configure braking units and resistors
Available on the instant stopping situation with big inertia load and no frequent braking
Not available on the situation of big inertia load and frequent braking(the energy consumed on the stator and its cooling is better than DC braking)

Short Circuit Braking

No need to configure braking units and resistors, capable of braking quickly
Applicable to the motors at quick start and stop or restart after braking
Not applicable to big inertia load and frequent braking

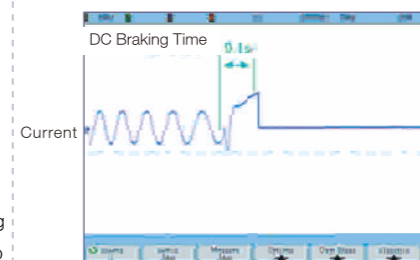

The current waveform in asynchronous motor SVPWM control mode with 100% braking current when the starting frequency is 10Hz and the braking time is 0.1s.

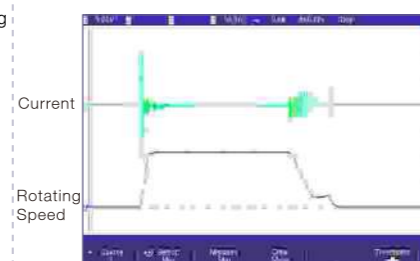

Short circuit braking waveform of synchronous motors. The acceleration time is 0.1s and the deceleration time is 0.4s(rated frequency: 100Hz,braking frequency :20Hz,braking time:0.5s)

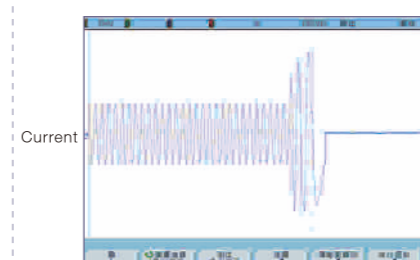

Flux braking current waveform when the running frequency is 50Hz, deceleration time is 0.1s with full load in asynchronous motor SVPWM control mode

Perfect Voltage and Current Control, Reducing the Fault Protection Times

OV Fault

Adjust the output frequency to avoid overvoltage of the DC bus during deceleration

OC Fault

Adjust the output frequency to avoid overcurrent of the VFD during acceleration

Continuous Running in Instantaneous Power Off

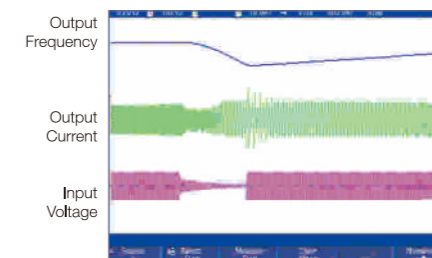

The VFD can keep running if the grid voltage drops and used in the situation with high requirement such as fibric and textile production line.

Multi-function with Simple Operation

Separate Air-duct

The separate air duct prevents the contaminants into the electronic parts/components and greatly improves the protective effect of the VFD, as well as its reliability and service life, to adapt various complicated site environments. It can also facilitate the heat-releasing in control cabinets and the heat-releasing design of the customer.

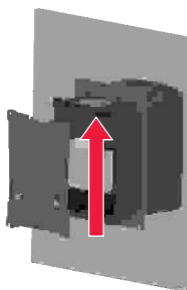

Multiple Installation Modes

Wall, flange and floor installation

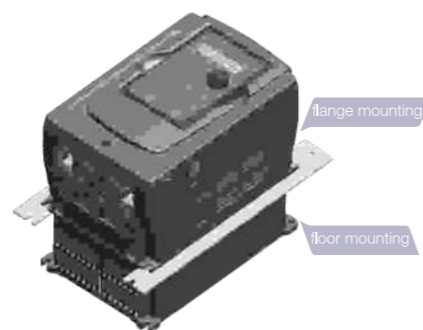

C3 Input Filters (Standard) and C2 Filters(Optional)

C3 input filter is embedded in the factory to meet different application requirements, save installation space and avoid the electromagnetic interference caused by incorrect selection and site installation.

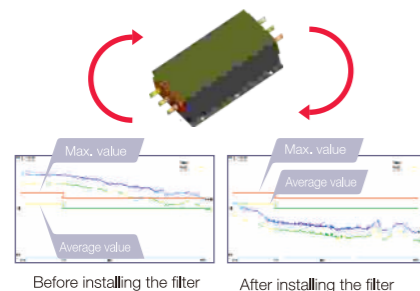

Conductive interference test of the power supply terminals

Remarks:
(1)C2 filter: EMC performance of the VFD achieves the limited usage requirement in civil environment.
(2)C3 filter: EMC performance of the VFD achieves the limited usage requirement in industrial environment.

Book Structure

Parallel installation
Little installation space with less cost and beautiful appearance.

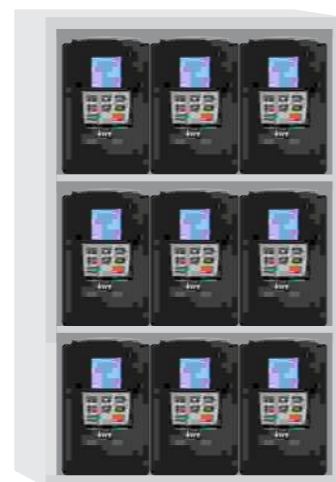

The Rivet Design Ensures Reliable Integration Connection

Greener Stronger corrosion-resistance Proper grounding Excellent EMC performance

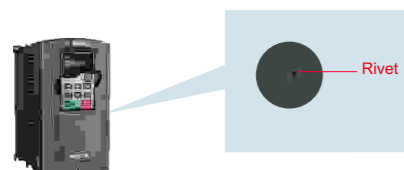

Abundant I/O Terminals

Terminals	Quantity	Features
Digital input	8 channels	1kHz NPN and PNP
High speed pulse input	1 channel	50kHz NPN and PNP
Analog input	3 channels	0~10V, 0~20mA, -10V~+10V
ON-OFF output	1 channel	Max. output frequency:1kHz
High speed pulse output	1 channel	Max. output frequency:50kHz
Analog output	2 channels	0~10V, 0~20mA
Relay output	2 channels	3A/250VAC, 1A/30VDC, NO+NC

Smaller Size

Due to the thermal simulation and advanced modularized design, the size of our product is reduced greatly. The width ratio between Goodrive310 and CHF100A is shown in the figure below (the Max. percentage is 50%)

Goodrive310/CHF100A

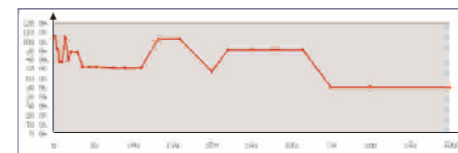

Various External Interfaces and Swappable Terminal Board Convenient for Replacement and Maintenance

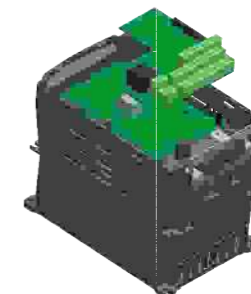

High Performance Keypad

The standard LED keypad supports parameters upload and download with Max. length of 200m and digital potentiometer. The optional external LCD keypad supports parameters loading and unloading with displaying 10 lines and 10 rows of Chinese characters and several languages



Standard LED Keypad



Optional LCD Keypad

Embedded Braking Units of 1.5-30kW VFDs

Reduce the occupied space and dynamic braking is available if install corresponding braking resistors.

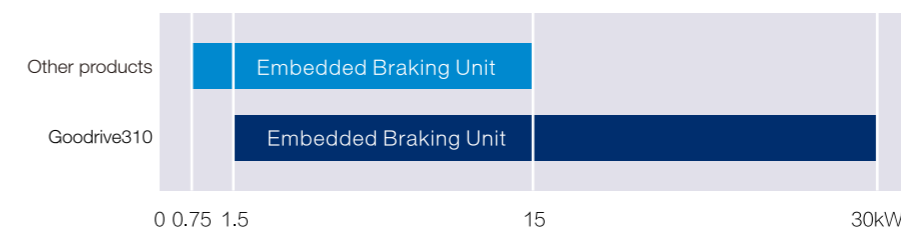

Supporting Common DC Bus

Reduce the power lost on braking resistor
Note the impact current and the capacity of input power

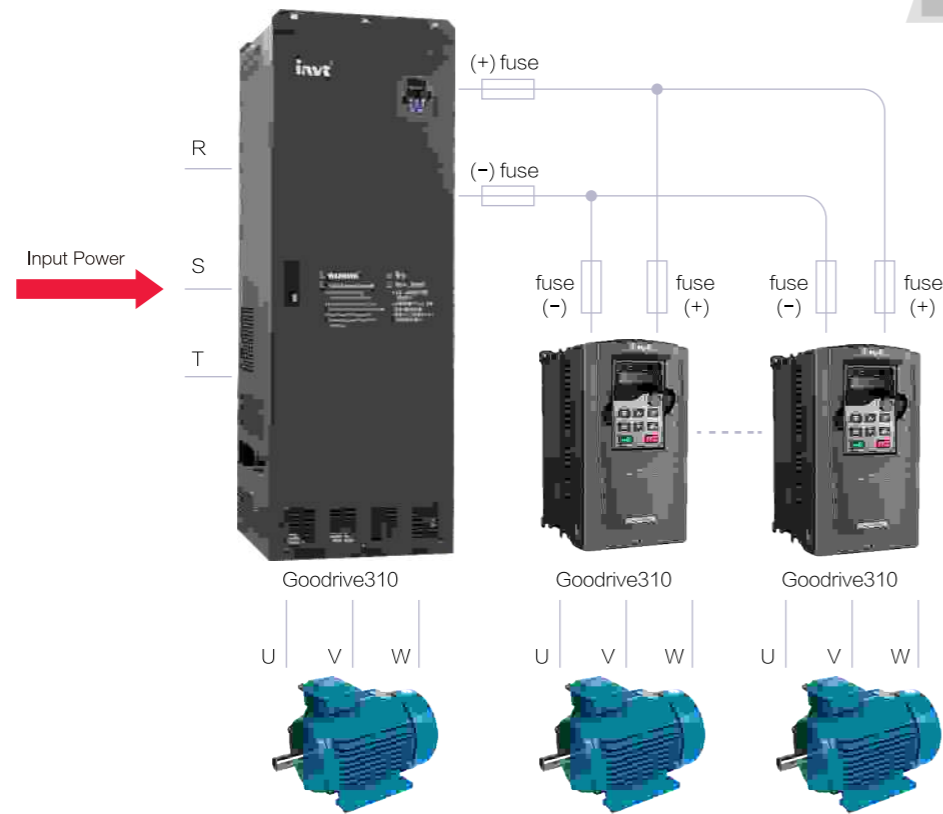

Available on DC Power Supply



Heavy-load Design

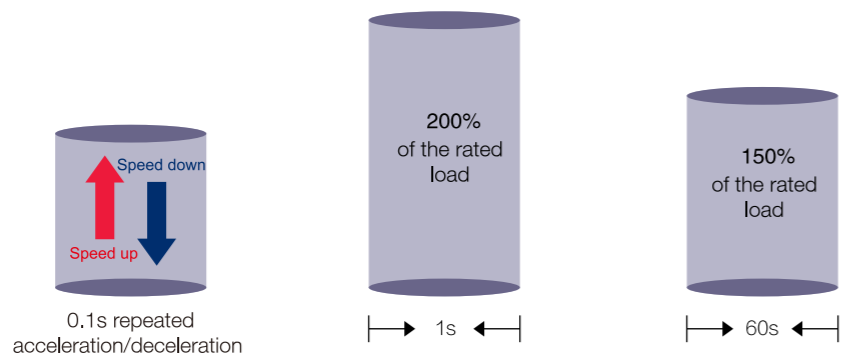

Various Application Function

Function	Effect
V/F separation setting	Meet the requirement of different power supplied and realize flexible setting to V/F curve
Two groups of motor parameters	Different motors can use the same VFD, reducing the cost, shifting between two motors making electrical control more convenient
Virtual terminal function	Make the middle variables as the local virtual I/O quantity, save the hardware configuration
Speed tracking	Available on asynchronous motor and permanent magnet synchronous motor and the situation of big inertia load, reversal rotating during starting and continuous frequent shifting
Digital signal, high speed pulse and relay	Provide more programmable and control modes
Electric power display	Display the total consumed energy. No need to use the power meter
Stop delay	Ensure the motor stop safely under control

Reliable Quality Assurance

The Product Design Follows IEC National Standards and Passed CE Test and UL Certification



Advanced Thermal Technology Makes Exact Thermal Design

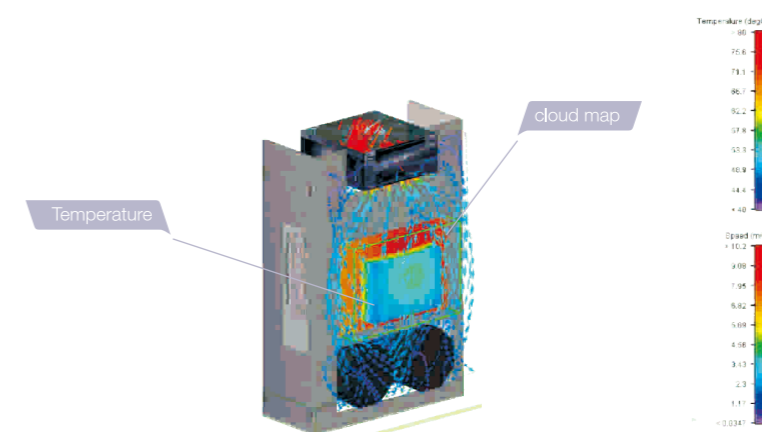

Perfect and Reliable Test System Ensure Products Adapt Complicated Site Environments and Achieved ACT Certificate of TÜV SÜD

Experiment Type	Experiment Name	Classification
Mechanical Reliability Experiments	Packaging Experiments	Package compression experiments
		Package Resonance imaging and storage test
		Package random vibration test
		Package dropping test
		Package rolling test
		Package dumping test
		Package inclined impact test
	Impact Test	Half-sine shock test(working and non-working state)
		Trapezoidal wave impulse test(non-working state)
	Vibration Test	Sinusoidal vibration test(working state)
Random vibration test(working and non-working state)		
Climatic Environmental Reliability Test	Temperature Experiment	Low temperature storage test
		High temperature storage test
		Low temperature working test
		High temperature working test
		Gradient temperature change test
		Temperature impact test
	Temperature & Humidity Test	Constant temperature & humidity test
		Alternation temperature & humidity test
	Salt Spray Test	Constant salt spray test
		Alternation salt spray test
	Low Air Pressure Test	Combined dry heat & low air pressure test
		Combined cold & low air pressure test

Remarks

The full name of ACT is Acceptance of Client's Testing, which means the German TÜV SÜD admit the technology level of the lab and accept their separate testing data and test reports officially.

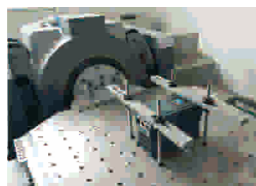

Electric Vibration System



Low Pressure Test Chamber & Constant temperature and humidity test chamber



Faster temperature chamber Thermal Shock Test Chamber

3 International Communication Protocols

Various Communication Modes: MODBUS Communication (Standard), PROFIBUS+Ethernet and CANopen+Ethernet Communication (Optional)

- Following functions are available through communication cards:
- Send control commands(starting, stopping and fault reset) to the VFD
 - Send speed or torque reference signal to the VFD
 - Read the state and actual value from the VFD
 - Modify the parameters of the VFD

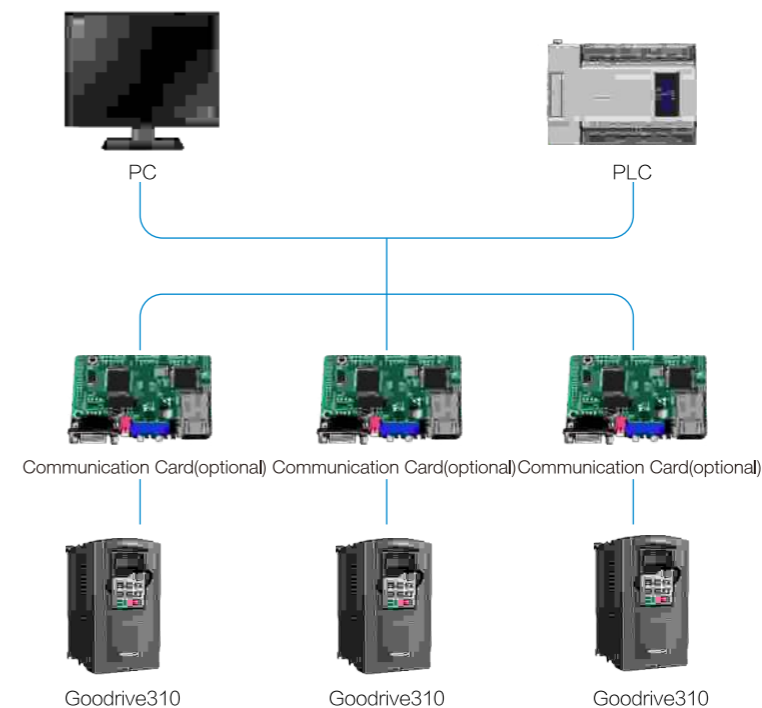

INVT Studio

INVT Studio is based on the VFD monitoring system with serial ports and Ethernet. It not only can modify and save the function codes of VFDs, but also be used as oscilloscope to collect and analyze the waveform data.

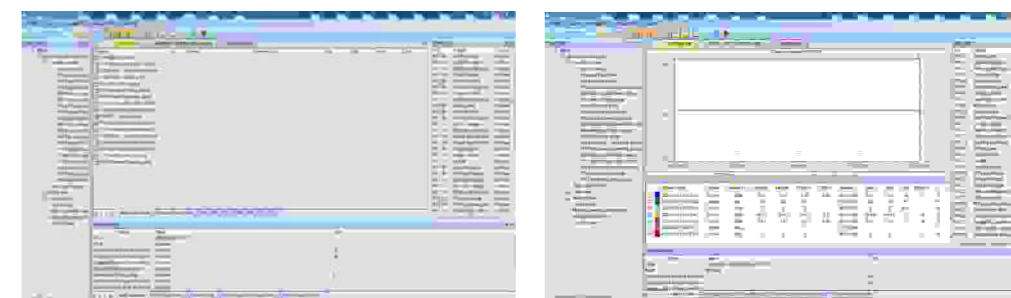
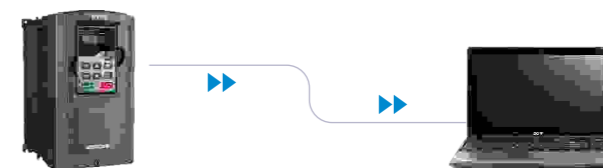

Applications

Permanent Magnet Synchronous Motor

Screw oil pumps, water pumps, compressors, hoisting, chemical fabric devices, plastic machinery, wood processing machinery and machine tools



Mine

Belt conveyors, air compressors, crushers, ball mills, centrifugal dehydrators

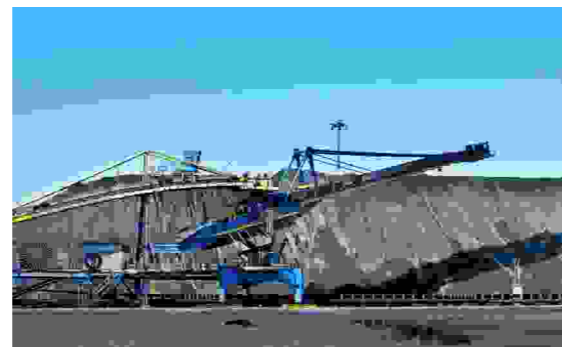

Machines Tools

Lathes, wood processing machinery, drilling machines, grinding machines, milling machines and air compressors



Textile

Carding machines, drawing machines, roving machines, ring spinning and winding machines, warping machines, circle machines, warp knitting machines, dyeing and finishing machines, shuttleless loom machines, non-woven production lines and draw texturing machines, industrial washing machines



Oil

Oil pumps, water injection pumps, compressors



Other Machineries

Hoisting, chemical, industrial, metal processing, EPS and constructive machines

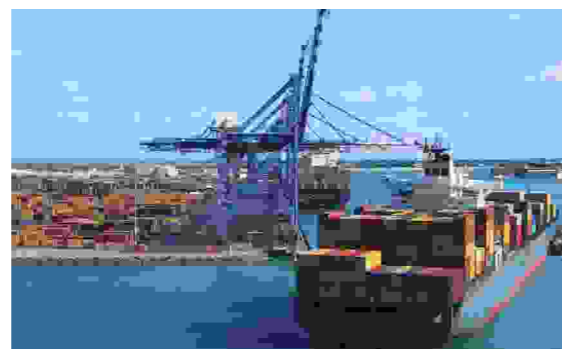

Technical Specifications

Functions		Specifications
Power input	Input voltage(V)	AC 3PH 200V~240V Rated voltage:220V AC 3PH 380V~480V Rated voltage:460V AC 3PH 520V~600V Rated voltage:575V
	Input frequency(Hz)	50Hz/60Hz Allowed range:47 63Hz
Power output	Output voltage(V)	0~input voltage
	Output frequency(Hz)	Standard:0 400Hz;(380V Goodrive310 special VFDs for medium-frequency:0 3200Hz)
Technical control feature	Control mode	SVPWM and SVC
	Motor type	Asynchronous and permanent magnet synchronous motors
	Speed ratio	Asynchronous motor 1:200 (SVC) synchronous motor 1:20 (SVC)
	Speed control accuracy	± 0.2% (SVC)
	Speed fluctuation	± 0.3%(SVC)
	Torque response	≤20ms(SVC)
	Torque control accuracy	10%(SVC)
Starting torque	Asynchronous motor:	0.25Hz/150%(SVC)
	Synchronous motor:	2.5 Hz/150%(SVC)
Overload capability	G Type:	150% of rated current: 1 minute
	P Type:	120% of rated current: 1 minute
		180% of rated current: 10 seconds 200% of rated current: 1 second
Running control feature	Frequency setting	Digital setting, analog setting, pulse frequency setting, multi-step speed running setting, simple PLC setting, PID setting, MODBUS communication setting, PROFIBUS communication setting and CANopen communication setting. Switch between the combination and single setting channel.
	Auto-adjustment of the voltage	Keep constant voltage automatically when the grid voltage transients
	Fault protection	Provide more than 30 fault protection functions: overcurrent, overvoltage, undervoltage, overheating, phase loss and overload, etc.
	Restart after rotating speed tracking	Smooth starting of the rotating motor
Peripheral interface	Terminal analog input resolution	≤20mV
	Terminal switch input resolution	≤2ms
	Analog Input	2 (AI1, AI2) 0~10V/0~20mA and 1 (AI3) -10~10V
	Analog output	2 (AO1, AO2) 0~10V /0~20mA
	Digital input	8 common inputs, the Max. frequency: 1kHz, 1 high speed input, the Max. frequency: 50kHz
	Digital output	1 high speed pulse output, the Max. frequency: 50kHz; 1 Y terminal open collector output
	Relay output	2 programmable relay outputs RO1A NO, RO1B NC, RO1C common terminal RO2A NO, RO2B NC, RO2C common terminal Contactor capacity: 3A/AC250V,1A/DC30V
Others	Mountable method	Wall and flange mountable
	Temperature of the running environment	-10~50°C, If above 40°C, derate 1% for every additional 1°C.
	Protective degree	IP20
	Cooling	Air-cooling
	Braking unit	Built-in(≤30kW) External for others
	Braking resistor	Optional
	EMC filter	Built-in C3 filter: meet the degree requirement of IEC61800-3 C3 Optional external C2 filter: meet the degree requirement of IEC61800-3 C2

*The overload capability of P type is convert from the G type's. For example, the coefficient of P type overload at 1 minute is: (The rated current of G type)*150%/(The rated current of P type), so the coefficient of GD310-018P-4 overload at 1 minute is: 32*150%/38=126%.

Type Designation Key

GD310-022G-4-UL

① ② ③ ④

Key	No.	Detailed description	Detailed content
Abbreviation	①	Product abbreviation	GD310 is short for Goodrive310
Rated power	②	Power range+load type	022: 22kW G: Constant torque load P: Variable torque load
Voltage degree	③	Voltage degree	2: AC 3PH 200V~240V Rated voltage: 220V 4: AC 3PH 380V~480V Rated voltage: 460V 6: AC 3PH 520V~600V Rated voltage: 575V
Certification	④	Certification standards	CE(Default) : Meet CE certification requirements UL: Meet UL certification requirements

Power Ratings

Model	Rated output power(kW)	Rated output horsepower (HP)	Rated input current (A)	Rated output current (A)	G.W.(kg)	N.W.(kg)
GD310-0R7G-2-UL	0.75	1	5	4.5	2.7	2
GD310-1R5G-2-UL	1.5	2	7.7	7	4	3.5
GD310-2R2G-2-UL	2.2	3	11	10	4	3.5
GD310-004G-2-UL	4	5	17	16	6.5	6
GD310-5R5G-2-UL	5.5	7.5	21	20	6.5	6
GD310-7R5G-2-UL	7.5	10	31	30	9	7.8
GD310-011G-2-UL	11	15	43	42	11.5	9.5
GD310-015G-2-UL	15	20	56	55	11.5	9.5
GD310-018G-2-UL	18.5	25	71	70	32	30
GD310-022G-2-UL	22	30	81	80	32	30
GD310-030G-2-UL	30	40	112	110	32	30
GD310-037G-2-UL	37	50	132	130	57	46.5
GD310-045G-2-UL	45	60	163	160	57	46.5
GD310-055G-2-UL	55	75	200	200	57	46.5
GD310-1R5G-4-UL	1.5	2	5	3.7	2.7	2
GD310-2R2G-4-UL	2.2	3	5.8	5	2.7	2
GD310-004G-4-UL	4	5	13.5	9.5	4	3.5
GD310-5R5G-4-UL	5.5	7.5	19.5	14	4	3.5
GD310-7R5G-4-UL	7.5	10	25	18.5	6.5	6
GD310-011G-4-UL	11	15	32	25	6.5	6
GD310-015G-4-UL	15	20	40	32	9	7.8
GD310-018G-4-UL	18.5	25	47	38	9	7.8
GD310-022G-4-UL	22	30	56	45	11.5	9.5
GD310-030G-4-UL	30	40	70	60	11.5	9.5
GD310-037G-4-UL	37	50	80	75	32	30
GD310-045G-4-UL	45	60	94	92	32	30
GD310-055G-4-UL	55	75	128	115	32	30
GD310-075G-4-UL	75	100	160	150	57	46.5
GD310-090G-4-UL	90	125	190	180	57	46.5
GD310-110G-4-UL	110	150	225	215	57	46.5
GD310-132G-4-UL	132	175	265	260	96	85
GD310-160G-4-UL	160	215	310	305	96	85
GD310-185G-4-UL	185	250	345	340	96	85
GD310-200G-4-UL	200	270	385	380	96	85
GD310-220G-4-UL	220	300	430	425	247	215
GD310-250G-4-UL	250	340	485	480	247	215
GD310-280G-4-UL	280	375	545	530	247	215
GD310-315G-4-UL	315	425	610	600	247	215
GD310-350G-4-UL	350	475	625	650	247	215
GD310-400G-4-UL	400	536	715	720	452	400

Model	Rated output power(kW)	Rated output horsepower (HP)	Rated input current (A)	Rated output current (A)	G.W.(kg)	N.W.(kg)
GD310-500G-4-UL	500	675	890	860	452	400
GD310-5R5P-4-UL	5.5	7.5	19.5	14	4	3.5
GD310-7R5P-4-UL	7.5	10	25	18.5	4	3.5
GD310-011P-4-UL	11	15	32	25	6.5	6
GD310-015P-4-UL	15	20	40	32	6.5	6
GD310-018P-4-UL	18.5	25	47	38	9	7.8
GD310-022P-4-UL	22	30	56	45	9	7.8
GD310-030P-4-UL	30	40	70	60	11.5	9.5
GD310-037P-4-UL	37	50	80	75	11.5	9.5
GD310-045P-4-UL	45	60	94	92	32	30
GD310-055P-4-UL	55	75	128	115	32	30
GD310-075P-4-UL	75	100	160	150	57	46.5
GD310-090P-4-UL	90	125	190	180	57	46.5
GD310-110P-4-UL	110	150	225	215	57	46.5
GD310-132P-4-UL	132	175	265	260	96	85
GD310-160P-4-UL	160	215	310	305	96	85
GD310-185P-4-UL	185	250	345	340	96	85
GD310-200P-4-UL	200	270	385	380	96	85
GD310-220P-4-UL	220	300	430	425	96	85
GD310-250P-4-UL	250	340	485	480	247	215
GD310-280P-4-UL	280	375	545	530	247	215
GD310-315P-4-UL	315	425	610	600	247	215
GD310-350P-4-UL	350	475	625	650	247	215
GD310-400P-4-UL	400	536	715	720	452	400
GD310-500P-4-UL	500	675	890	860	452	400
GD310-018G-6-UL	18.5	25	35	27	32	30
GD310-022G-6-UL	22	30	40	35	32	30
GD310-030G-6-UL	30	40	47	45	32	30
GD310-037G-6-UL	37	50	52	52	57	46.5
GD310-045G-6-UL	45	60	65	62	57	46.5
GD310-055G-6-UL	55	75	85	86	57	46.5
GD310-075G-6-UL	75	100	95	98	57	46.5
GD310-090G-6-UL	90	125	118	120	57	46.5
GD310-110G-6-UL	110	150	145	150	57	46.5

Dimensions (unit: mm)

Installation Size for Wall Installation

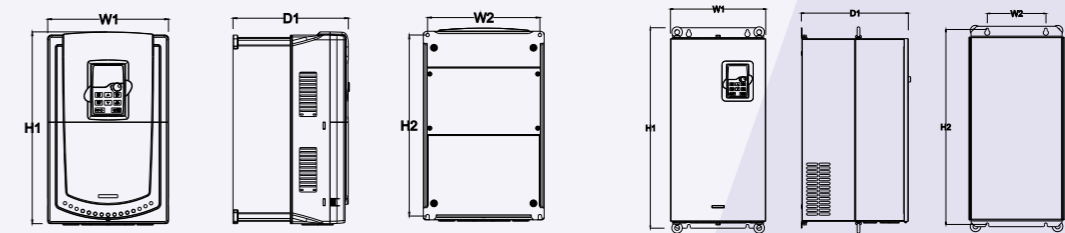

Wall installation of 460V 1.5~30kW VFDs

Wall installation of 220V 37~55kW VFDs
Wall installation of 460V 37~110kW VFDs

Wall installation dimension of 220V 37~55kW (unit: mm)

Power Rating	W1	W2	H1	H2	D1	Installation Holes
37kW-55kW	325	200	680	661	365	9.5

Wall installation dimension of 460V 1R5G-315G/5R5P-110P (unit: mm)

Power Rating	W1	W2	H1	H2	D1	Installation Holes
G type: 1.5kW~2.2kW	126	115	193	175	174.5	5
G type: 4kW~5.5kW P type: 5.5kW~7.5kW	146	131	263	243.5	181	6
G type: 7.5kW~11kW P type: 11~15kW	170	151	331.5	303.5	216	6
G type: 15kW~18kW P type: 18~22kW	230	210	342	311	216	6
G type: 22kW~30kW P type: 30kW~37kW	255	237	407	384	245	7
G type: 37kW~55kW P type: 45kW~55kW	270	130	555	540	325	7
G/P type: 75kW~110kW	325	200	680	661	365	9.5

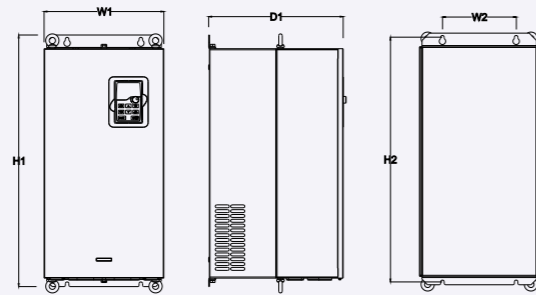

Wall installation of 575V 18.5~110kW VFDs

Power Rating	W1	W2	H1	H2	D1	Installation Holes
18.5kW~37kW	270	130	555	540	325	7
45kW~110kW	325	200	680	661	365	9.5

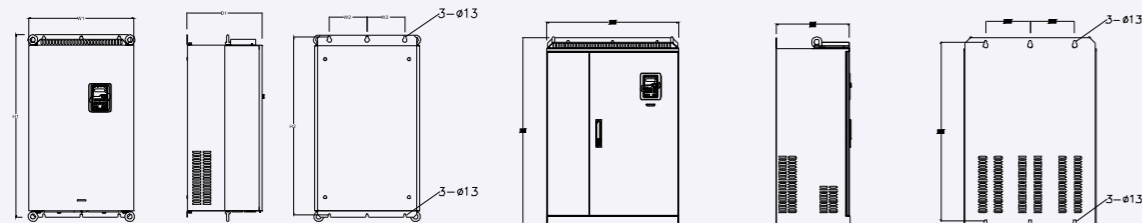

Wall installation of 460V 132G-200G/132P-220P VFDs

Wall installation of 460V 220G-315G/250P-350P VFDs

Wall installation dimension of 460V 132G-315G/132P-350P (unit: mm)

Power Rating	W1	W2	H1	H2	D1	Installation Holes
G type: 132kW-200kW P type: 132kW-220kW	500	180	870	850	360	11
G type: 220kW-315kW P type: 250kW-350kW	600	230	960	926	380	13

Installation Size for Flange Installation

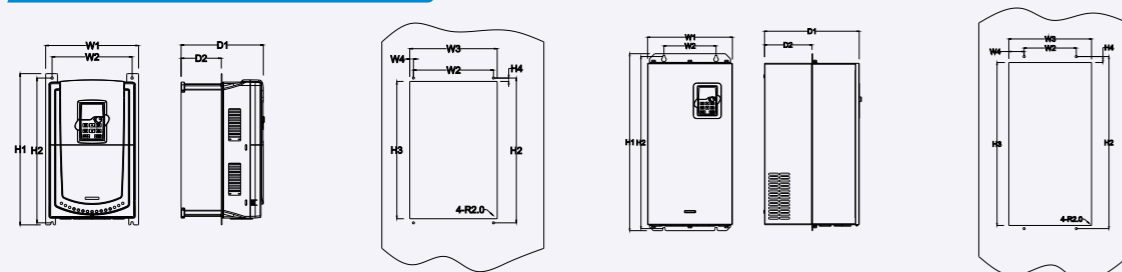

Flange installation of 460V 1.5~30kW VFDs

Flange installation of 220V 37~55kW VFDs
Flange installation of 460V 37~110kW VFDs

Flange installation dimension of 220V 37~55kW VFDs (unit:mm)

Power Rating	W1	W2	W3	W4	H1	H2	H3	H4	D1	D2	Installation Holes
37kW~55kW	325	200	317	58.5	680	661	626	23	363	182	9.5

Flange installation dimension of 460V 1.5~110kW VFDs (unit:mm)

Power Rating	W1	W2	W3	W4	H1	H2	H3	H4	D1	D2	Installation Holes
1.5kW~2.2kW	150	115	130	7.5	234	220	190	16.5	174.5	65.5	5
4kW~5.5kW	170	131	150	9.5	292	276	260	10	181	79.5	6
7.5kW~11kW	191	151	174	11.5	370	351	324	15	216.2	113	6
15kW~18.5kW	250	210	234	12	375	356	334	10	216	108	6
22kW~30kW	275	237	259	11	445	426	404	10	245	119	7
37kW~55kW	270	130	261	65.5	555	540	516	17	325	167	7
75kW~110kW	325	200	317	58.5	680	661	626	23	363	182	9.5

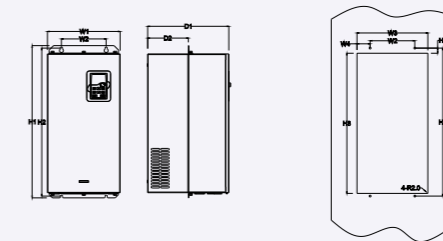

Flange installation of 575V 18.5~110kW VFDs

Flange installation dimension of 575V 18.5~110kW VFDs (unit:mm)

Power Rating	W1	W2	W3	W4	H1	H2	H3	H4	D1	D2	Installation Holes
18.5kW~37kW	270	130	261	65.5	555	540	516	17	325	167	7
45kW~110kW	325	200	317	58.5	680	661	626	23	363	182	9.5

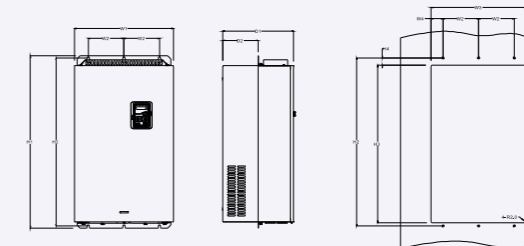

Flange installation of 460V 132G-200G/132P-220P kW VFDs

Flange installation dimension of 460V 132G-200G/132P-220P VFDs (unit:mm)

Power Rating	W1	W2	W3	W4	H1	H2	H3	H4	D1	D2	Installation Holes
G type: 132kW-200kW P type: 132kW-220kW	500	180	480	60	870	850	796	37	358	178.5	11

Installation Size for Floor Installation

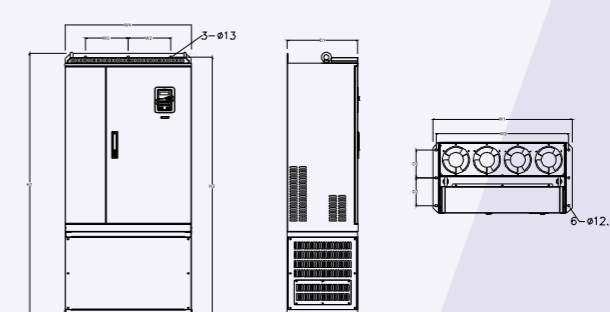

Floor installation of 460V 220G-315G/250P-350P VFDs

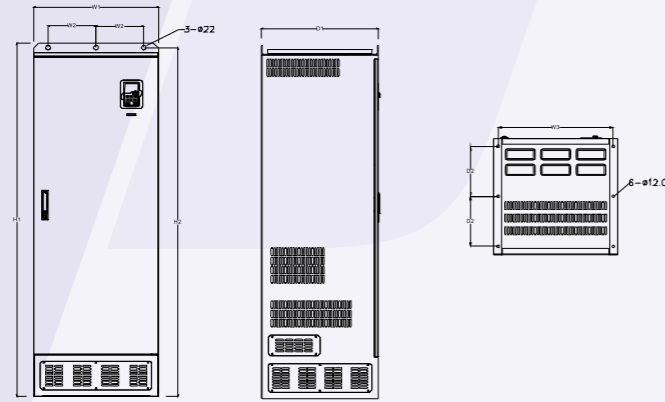

Floor installation of 460V 350G-500G/400P-500P VFDs

Floor installation dimension of 460V 220G-500G VFDs (unit:mm)

Power Rating	W1	W2	W3	W4	H1	H2	D1	D2	Installation Holes
G/P type :220kW-315kW	750	230	714	680	1410	1390	380	150	13/12
G/P type: 350kW-500GkW	620	230	573	/	1700	1678	560	240	22/12

Optional Parts

Flange Mounting Panel

Optional for VFDs of 1.5 ~ 30kW in flange installation; not optional for VFDs of 37 ~ 55kW in flange installation



Heat-releasing Hole

VFD needs to derate when selecting a cover consult with the INVT technicians for the detailed information.



Installation Bracket for the Keypad

Use M3 screws or installation bracket to fix the keypad. The installation bracket of 1.5 ~ 30kW VFDs are optional, others are standard.



Communication Card

PROFIBUS+Ethernet communication card
CANopen +Ethernet communication card



LCD Keypad

10 rows of DH displaying
Compatible with the LED keypad



Assistant Power (AC Single Phase 220V)

Provide for a safer and more convenient VFD debugging when the main power supply is power off(note as non-standard assistant power supply)

Reactor

Model	Input reactor	DC reactor	Output reactor
GD310-0R7G-2-UL	ACL2-2R2-4-UL	-	OCL2-2R2-4-UL
GD310-1R5G-2-UL	ACL2-004-4-UL	-	OCL2-004-4-UL
GD310-2R2G-2-UL	ACL2-004-4-UL	-	OCL2-004-4-UL
GD310-004G-2-UL	ACL2-7R5-4-UL	-	OCL2-7R5-4-UL
GD310-5R5G-2-UL	ACL2-011-4-UL	-	OCL2-011-4-UL
GD310-7R5G-2-UL	ACL2-015-4-UL	-	OCL2-015-4-UL
GD310-011G-2-UL	ACL2-022-4-UL	-	OCL2-022-4-UL
GD310-015G-2-UL	ACL2-030-4-UL	-	OCL2-030-4-UL
GD310-018G-2-UL	ACL2-037-4-UL	DCL2-037-4-UL	OCL2-037-4-UL
GD310-022G-2-UL	ACL2-045-4-UL	DCL2-045-4-UL	OCL2-045-4-UL
GD310-030G-2-UL	ACL2-055-4-UL	DCL2-055-4-UL	OCL2-055-4-UL
GD310-037G-2-UL	ACL2-075-4-UL	DCL2-075-4-UL	OCL2-075-4-UL
GD310-045G-2-UL	ACL2-090-4-UL	DCL2-090-4-UL	OCL2-090-4-UL
GD310-055G-2-UL	ACL2-110-4-UL	DCL2-110-4-UL	OCL2-110-4-UL
GD310-1R5G-4-UL	ACL2-1R5-4-UL	-	OCL2-1R5-4-UL
GD310-2R2G-4-UL	ACL2-2R2-4-UL	-	OCL2-2R2-4-UL
GD310-004G-4-UL	ACL2-004-4-UL	-	OCL2-004-4-UL
GD310-5R5G-4-UL	ACL2-5R5-4-UL	-	OCL2-5R5-4-UL
GD310-7R5G-4-UL	ACL2-7R5-4-UL	-	OCL2-7R5-4-UL
GD310-011G-4-UL	ACL2-011-4-UL	-	OCL2-011-4-UL
GD310-015G-4-UL	ACL2-015-4-UL	-	OCL2-015-4-UL
GD310-018G-4-UL	ACL2-018-4-UL	-	OCL2-018-4-UL
GD310-022G-4-UL	ACL2-022-4-UL	-	OCL2-022-4-UL
GD310-030G-4-UL	ACL2-030-4-UL	-	OCL2-030-4-UL
GD310-037G-4-UL	ACL2-037-4-UL	DCL2-037-4-UL	OCL2-037-4-UL
GD310-045G-4-UL	ACL2-045-4-UL	DCL2-045-4-UL	OCL2-045-4-UL
GD310-055G-4-UL	ACL2-055-4-UL	DCL2-055-4-UL	OCL2-055-4-UL
GD310-075G-4-UL	ACL2-075-4-UL	DCL2-075-4-UL	OCL2-075-4-UL
GD310-090G-4-UL	ACL2-110-4-UL	DCL2-090-4-UL	OCL2-110-4-UL
GD310-110G-4-UL	ACL2-110-4-UL	DCL2-132-4-UL	OCL2-110-4-UL
GD310-132G-4-UL	ACL2-132-4-UL	DCL2-132-4-UL	OCL2-132-4-UL
GD310-160G-4-UL	ACL2-160-4-UL	DCL2-160-4-UL	OCL2-160-4-UL
GD310-185G-4-UL	ACL2-200-4-UL	DCL2-220-4-UL	OCL2-200-4-UL
GD310-200G-4-UL	ACL2-200-4-UL	DCL2-220-4-UL	OCL2-200-4-UL
GD310-220G-4-UL	ACL2-200-4-UL	DCL2-280-4-UL	OCL2-250-4-UL
GD310-250G-4-UL	Standard	DCL2-280-4-UL	OCL2-280-4-UL
GD310-280G-4-UL	Standard	DCL2-315-4-UL	OCL2-315-4-UL
GD310-315G-4-UL	Standard	DCL2-400-4-UL	OCL2-350-4-UL
GD310-350G-4-UL	Standard	DCL2-400-4-UL	OCL2-400-4-UL
GD310-400G-4-UL	Standard	DCL2-500-4-UL	OCL2-500-4-UL
GD310-500G-4-UL	Standard	DCL2-500-4-UL	OCL2-500-4-UL
GD310-5R5P-4-UL	ACL2-004-4-UL	-	OCL2-004-4-UL
GD310-7R5P-4-UL	ACL2-5R5-4-UL	-	OCL2-5R5-4-UL
GD310-011P-4-UL	ACL2-7R5-4-UL	-	OCL2-7R5-4-UL
GD310-015P-4-UL	ACL2-011-4-UL	-	OCL2-011-4-UL
GD310-018P-4-UL	ACL2-015-4-UL	-	OCL2-015-4-UL
GD310-022P-4-UL	ACL2-018-4-UL	-	OCL2-018-4-UL
GD310-030P-4-UL	ACL2-022-4-UL	-	OCL2-022-4-UL
GD310-037P-4-UL	ACL2-030-4-UL	-	OCL2-030-4-UL
GD310-045P-4-UL	ACL2-037-4-UL	DCL2-037-4-UL	OCL2-037-4-UL
GD310-055P-4-UL	ACL2-045-4-UL	DCL2-045-4-UL	OCL2-045-4-UL

Model	Input reactor	DC reactor	Output reactor
GD310-075P-4-UL	ACL2-075-4-UL	DCL2-075-4-UL	OCL2-075-4-UL
GD310-090P-4-UL	ACL2-090-4-UL	DCL2-090-4-UL	OCL2-090-4-UL
GD310-110P-4-UL	ACL2-132-4-UL	DCL2-132-4-UL	OCL2-132-4-UL
GD310-132P-4-UL	ACL2-160-4-UL	DCL2-160-4-UL	OCL2-160-4-UL
GD310-160P-4-UL	ACL2-200-4-UL	DCL2-200-4-UL	OCL2-200-4-UL
GD310-185P-4-UL	Standard	DCL2-280-4-UL	OCL2-250-4-UL
GD310-200P-4-UL		OCL2-280-4-UL	
GD310-220P-4-UL		OCL2-315-4-UL	
GD310-250P-4-UL		OCL2-315-4-UL	
GD310-280P-4-UL	Standard	DCL2-350-4-UL	OCL2-350-4-UL
GD310-315P-4-UL		OCL2-500-4-UL	
GD310-350P-4-UL		OCL2-500-4-UL	
GD310-400P-4-UL		OCL2-500-4-UL	
GD310-500P-4-UL	ACL2-022G-6-UL	DCL2-022G-6-UL	OCL2-022G-6-UL
GD310-018G-6-UL	ACL2-022G-6-UL	DCL2-030G-6-UL	OCL2-030G-6-UL
GD310-022G-6-UL	ACL2-030G-6-UL	DCL2-030G-6-UL	OCL2-030G-6-UL
GD310-030G-6-UL	ACL2-037G-6-UL	DCL2-037G-6-UL	OCL2-037G-6-UL
GD310-037G-6-UL	ACL2-045G-6-UL	DCL2-045G-6-UL	OCL2-045G-6-UL
GD310-045G-6-UL	ACL2-055G-6-UL	DCL2-055G-6-UL	OCL2-055G-6-UL
GD310-055G-6-UL	ACL2-075G-6-UL	DCL2-075G-6-UL	OCL2-075G-6-UL
GD310-075G-6-UL	ACL2-090G-6-UL	DCL2-090G-6-UL	OCL2-090G-6-UL
GD310-090G-6-UL	ACL2-110G-6-UL	DCL2-110G-6-UL	OCL2-110G-6-UL
GD310-110G-6-UL			

- Note:
1. The rated derate voltage of the input reactor is 2%±15%.
 2. The power factor of the input side is above 90% after installing DC reactor.
 3. The rated derate voltage of the output reactor is 1%±15%.
 4. Above options are external, the customer should indicate when purchasing.

Sales Network

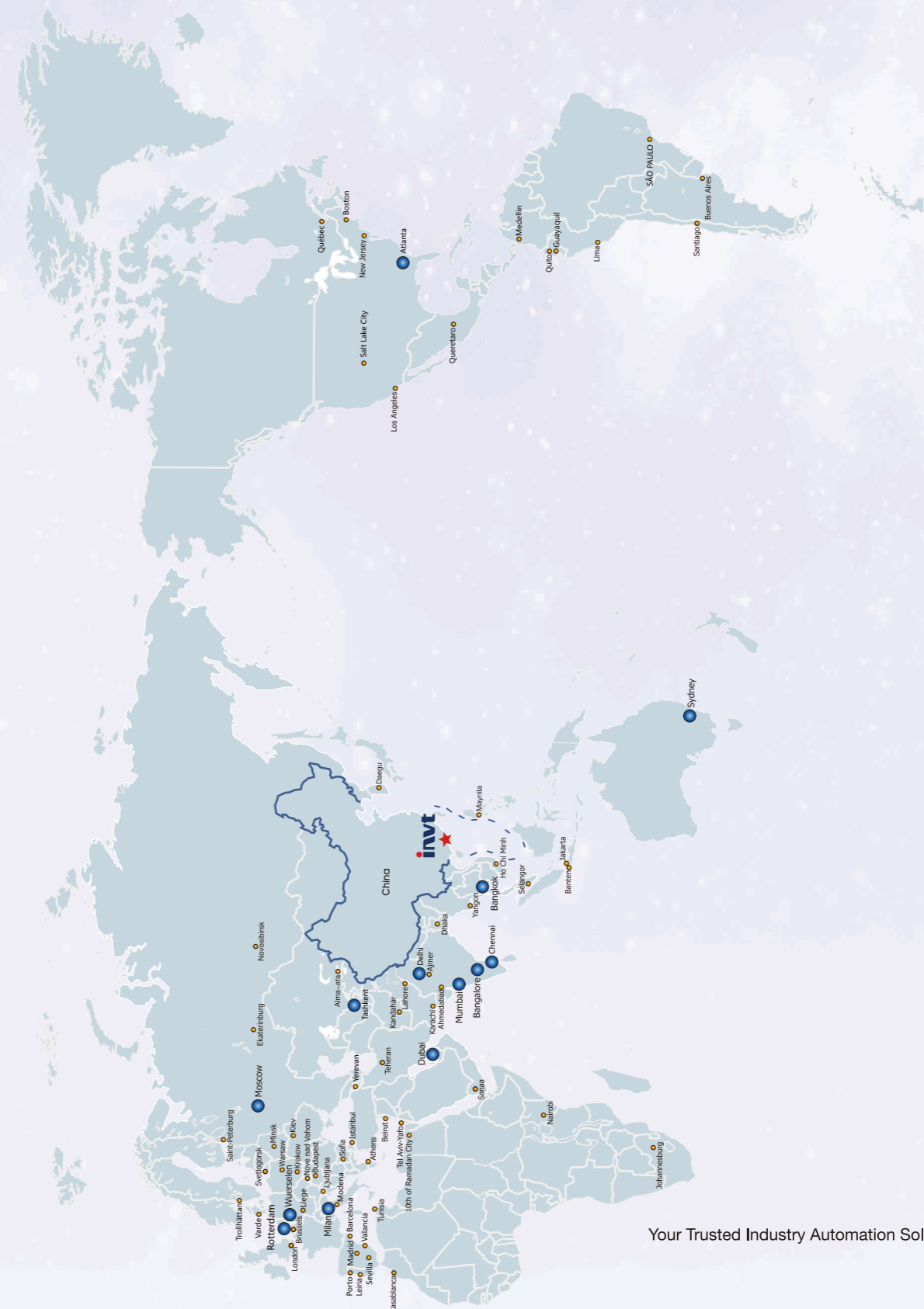

- ★ INVT Headquarters
- INVT Sales & Service in 13 countries
- Sales and Service Partners in 63 countries

Your Trusted Industry Automation Solution Provider

